

Dec. 15, 1936.

W. E. GROENKE

2,064,537

CAN BODY

Filed Nov. 23, 1933

2 Sheets-Sheet 1

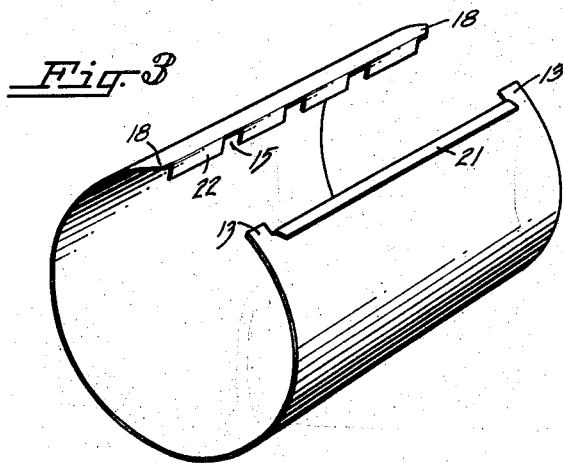
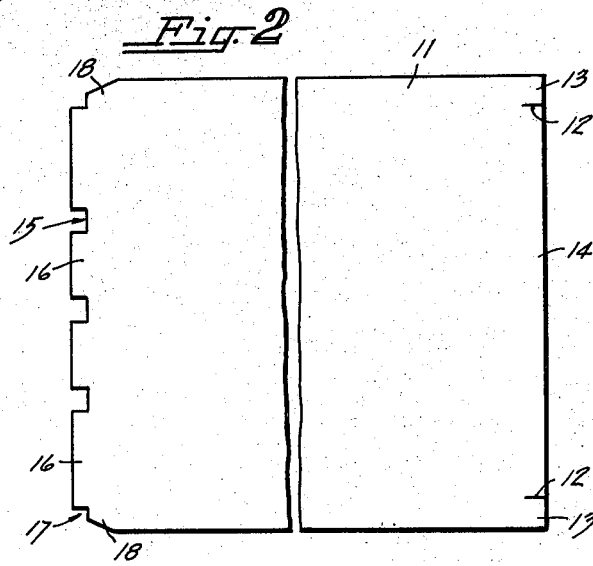
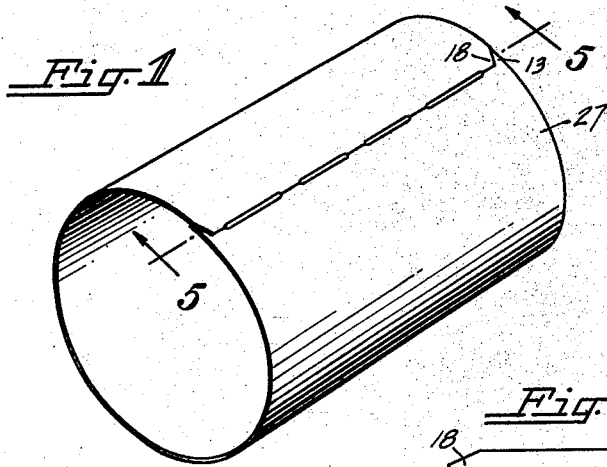

INVENTOR
Walter E. Groenke
BY *Joyce D. Shouburg*
Charles H. Crife
ATTORNEYS

Dec. 15, 1936.

W. E. GROENKE

2,064,537

CAN BODY

Filed Nov. 23, 1933

2 Sheets-Sheet 2

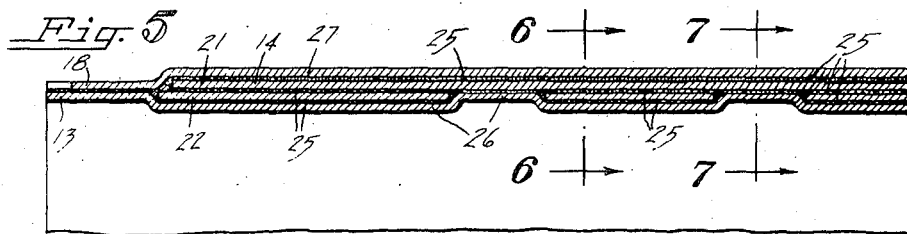
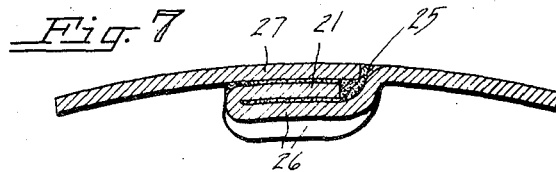
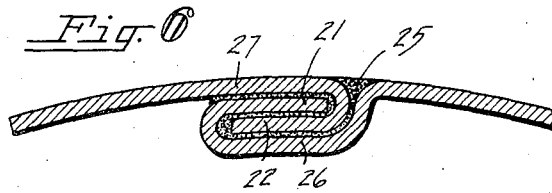
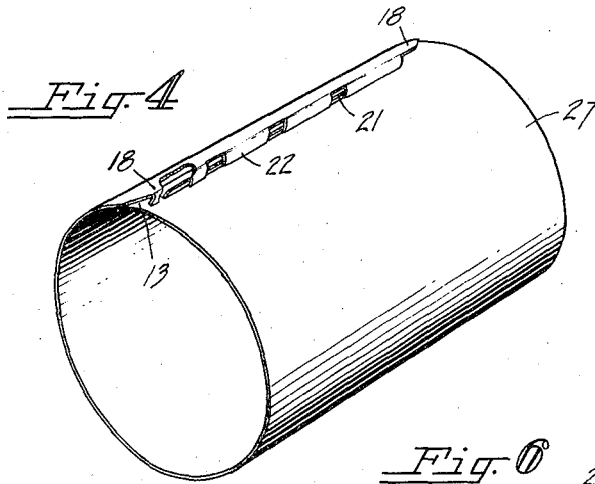

INVENTOR
Walter E. Groenke
BY *Irvin D. Thompson*
Charles H. Case
ATTORNEYS

UNITED STATES PATENT OFFICE

2,064,537

CAN BODY

Walter E. Groenke, Maywood, Ill., assignor to
American Can Company, New York, N. Y., a
corporation of New Jersey

Application November 23, 1933, Serial No. 699,455

3 Claims. (Cl. 220—75)

The present invention relates in general to the reinforcement of cans and has more particular reference to improvements in reinforcing the side seam of the can body, being in some respects an improvement upon the can body disclosed in the Young Patent No. 1,685,384, issued September 25, 1928.

The invention contemplates the provision of a can capable of withstanding high internal pressures such as develop in some liquids, such as beer, when enclosed and hermetically sealed in the cans.

The invention contemplates the provision of a side seam construction which consists of a single continuous hook section extending along one edge of the blank of the can body and a series of spaced hook sections along the other edge, the latter engaging with the continuous hook section when the blank edges are interlocked and the parts are finally soldered together with the solder uniting all of the thicknesses of metal to provide the improved reinforced side seam.

An object of the invention is the provision of a can body, capable of withstanding high internal pressures, having a reinforced side seam of novel construction made up of a plurality of sections or zones of different thicknesses of metal and vent spaces or cutaway parts, which permit the escape of air or gases and the sweating or penetration of solder between all the sections and between all the thicknesses of metal, thereby producing a side seam of maximum strength and pressure resistance.

A further object of the invention is the provision of a can body having a reinforced side seam which may be commercially manufactured without making appreciable alterations in the machine parts at present employed in the manufacture of cans.

A still further object of the invention is the provision of a soldered side seam having cooperating hook sections, portions of which are cut away to provide vent passages to enable the escape of air or gases from the seam during the application of solder.

Numerous other objects and advantages of the invention will be apparent as it is better understood from the following description, which, taken in connection with the accompanying drawings, discloses a preferred embodiment thereof.

Referring to the drawings:

Figure 1 is a perspective view of a can body embodying the present invention, this body having a closed and hermetically sealed side seam;

Fig. 2 is a face view of a body blank properly cut to provide for the can body of Fig. 1, the middle part of the blank being broken away;

Fig. 3 is a perspective view of the formed blank after it has been brought into cylindrical shape and after its opposed edges have been bent into hook form;

Fig. 4 is a view similar to Fig. 3 illustrating the formed blank interlocked and its opposed hook edges in position for final bending or bumping into side seam position;

Fig. 5 is an enlarged longitudinal sectional view of a part of the side seam and the adjacent body wall being taken substantially along the line 5—5 in Fig. 1 and illustrating the different zones of thickness of the blank parts in the side seam; and

Figs. 6 and 7 are enlarged fragmentary transverse sectional views of the side seam taken substantially along the respective lines 6—6 and 7—7 in Fig. 5.

As illustrated in the drawings and particularly in Fig. 2, a formed and notched body blank 11 is first provided. One of the free edges of the blank 11 is provided with slits 12, a slit being formed adjacent each end of the blank edge and setting off two end lap sections 13 and a longitudinal central part 14. On the opposite edge of the blank a series of notches 15 are cut in the edge to provide cut away portions or vent spaces between intermediate sections 16. The outer ends of the two outside sections 16 are notched at 17 and cut away at an angle or taper to provide an angular end lap portion 18.

The formed blank is rolled or otherwise bent into cylindrical shape as illustrated in Fig. 3 and the longitudinal blank edge 14 is bent back to preferably provide a single, continuous turned-back hook 21. In a similar manner the edge sections 16 on the opposite side of the blank are bent in to provide a series of turned-in hook sections 22.

The open edges of the formed blank are then united, the longitudinal or single, continuous hook 21 being engaged with the turned in hook sections 22 as illustrated in Fig. 4. The angular or cut away end lap portions 18 come just outside of the end lap sections 13. A bumped side seam is then formed by pressing together the interlocked parts, the angular end lap sections 18 and the end lap sections 13 being also pressed into close engagement.

In this bumping or pressing of the seam parts the metal along the edge directly under the hook 21 and directly under the spaces 15 is

pressed outwardly into all of these spaces between the engaged hook sections 22 as best illustrated in Fig. 5. The side seam as considered along its length then consists of a zone at each end which embodies two thicknesses of lapped metal being the engaged lap portions 13, 18, also a four-thickness zone at the interlocked section (also illustrated in Fig. 6) being the engaged hooks 21, 22, and finally a three-thickness zone intermediate the four-thickness zones (also illustrated in Fig. 7) being the pressed in sections of the hook 21 within the spaces 15.

The bending of the edges of the blank, the interlocking of the hook parts and the pressing together of the seam sections as just described are all done automatically during the manufacture of the can by the usual body maker or other suitable type of machine. The side seam is then hermetically sealed by the introduction of solder applied from the outside in the usual manner. The distribution of the solder in the finally prepared seam is graphically illustrated in Figs. 5, 6, and 7, the solder being indicated by the numeral 25. The solder it will be observed extends between the lapped ends of the blank and in between the sections 13—18, this being in the two-thickness zone just described.

In the four-thickness zone of the side seam the solder 25 flows in over the can wall which is adjacent to and directly under the hook 21, this part of the seam being the portion pressed in during the bumping operation and being designated by the numeral 26. This much of the solder is under the inner or lower face of the hook 22 and joins the adjacent parts 22, 26. The solder thence flows around the end of the hook 22 and in between the upper wall thereof and the lower face of the longitudinal hook 21, thus joining the adjacent parts 21, 22. Solder also flows in between the outside body wall adjacent its edge (designated by the numeral 27) and the outer or upper surface of the hook 21, this solder mostly entering through the spaces 15 at the three-thickness zones and spreading in both directions longitudinally of the seam from the opposed edges of the hooks 22 toward the middle of these hooks. Thus all four thicknesses of metal making up the four-thickness zone of the side seam are united by solder.

In the three-thickness zone at the spaces 15 and intermediate the hook sections 22 it will be observed (Figs. 5 and 7) that the solder flows in between the body wall part 26 and the hook 21 and also in between the outer surface of the latter and the outside body wall 27. It also flows laterally into the four-thickness zone as described in the preceding paragraph. The three thicknesses of metal are thus firmly united. There is a venting of the side seam, air or gases within the seam escaping ahead of the solder flow and into the interior of the can by way of the space between the adjacent parts 21, 27. This insures a thoroughly sweated side seam in all sections.

This construction and use of zones of varying thicknesses together with the complete venting reinforces the side seam and prevents any pulling away or unrolling of the intermediate

lock seam parts. The resulting can body is much stronger than a can body not so reinforced and experiment has shown that such can body may be embodied in a can suitable for packaging beer where great internal pressures are often developed.

It is thought that the invention and many of its attendant advantages will be understood from the foregoing description, and it will be apparent that various changes may be made in the form, construction and arrangement of the parts without departing from the spirit and scope of the invention or sacrificing all of its material advantages, the form hereinbefore described being merely a preferred embodiment thereof.

I claim:

1. A reenforced can body capable of resisting high internal pressures, said can body being formed from a blank having two of its opposed marginal edges bent into oppositely directed hooks to interlock said edges into a side seam when said blank is brought to tubular form, at least one of said hooks having cutaway portions dividing it into a plurality of hook sections with wide vent spaces between said hook sections, said vent spaces being substantially filled by opposed body wall parts, to permit solder to penetrate between all thicknesses of metal of said seam when said seam is bumped and soldered.

2. A reenforced can body capable of resisting high internal pressures, said can body comprising a tubular blank having its opposed marginal edges bent into oppositely directed hooks interlocked into a side seam, at least one of said hooks having cutaway portions dividing it into a plurality of hook sections with wide vent spaces between said hook sections, the body wall portions adjacent said spaces extending into and filling said spaces to reinforce said side seam and provide a metal to metal contact throughout, said metal to metal contact throughout said side seam permitting solder to penetrate by capillary action between all thicknesses of metal of said seam when said seam is bumped and soldered.

3. A reenforced can body capable of resisting high internal pressures, said can body comprising a tubular blank having its opposed marginal edges bent into oppositely directed hooks interlocked into a side seam, one of said hooks having a plurality of spaced cutaway portions constituting vent spaces dividing such hook into a plurality of spaced hook sections, the body wall portions adjacent said spaces extending into and substantially filling said spaces to reinforce said side seam and to provide a metal to metal contact throughout, said metal to metal contact throughout said side seam permitting solder to penetrate between all thicknesses of metal of said seam when said seam is bumped and soldered, said interlocked parts and the adjacent body wall at the said spaces between the hook sections providing a four thickness zone in the side seam at the interlocked parts, and a three thickness zone in the side seam intermediate said interlocked parts.

WALTER E. GROENKE.